

# **IWAKI Air Pump**

---

**BAN-0510/-0505**

---

## **Instruction Manual**

---

 Read this manual before use of product

Thank you for selecting an IWAKI BAN-0510/-0505 air pump. This instruction manual deals with "Safety Instructions", "Outline", "Installation", "Operation" and "Maintenance" sections.

Please read through this instruction manual to ensure the optimum performance, safety and service of your pump.

## Contents

<b>Safety Instructions</b> .....	<b>1</b>
<i>Outline</i>	
1. Unpacking & Inspection .....	3
2. Operating principle .....	3
3. Identification code .....	4
4. Specifications .....	4
5. Outer dimension .....	5
6. Performance curve .....	6
7. Overview & Label .....	6
8. Part names & Structure .....	7
<i>Installation</i>	
1. Before installation .....	8
2. Installation/Tubing/Electrical wiring .....	10
<i>Operation</i>	
1. Before operation .....	13
2. Pump operation .....	14
<i>Maintenance</i>	
1. Troubleshooting .....	16
2. Maintenance & Inspection .....	16
3. Wear part replacement .....	17



*This instruction manual should be kept on hand by the end user for quick reference.*

*Contact us or your nearest distributor if you have any questions.*



## Important Instruction

### For the Safe and Correct Handling of the Pump

- "Safety Instruction" section deals with important details about handling of the product. Before use, read this section carefully for the prevention of personnel injury or property damage.
- Observe the instructions accompanied with "WARNING" or "CAUTION" in this manual. These instructions are very important for protecting pump users from dangerous situations.
- The symbols on this instruction manual have the following meanings:

 <b>WARNING</b>	<b>Nonobservance or misapplication of the contents of "Warning" section could lead to a serious accident which may result in death.</b>
 <b>CAUTION</b>	<b>Nonobservance or misapplication of the contents of "Caution" section could lead to personal injury or property damage.</b>

### Types of Symbols

	Indicates a prohibited action or procedure. Inside or near this circle, a concrete and practical image of the activity to be avoided is depicted.
	Indicates an important action or procedure which must be performed or carried out without fail. Failure to follow the instructions herein can lead to malfunction or damage to the pump.

### **Export Restrictions**

Technical information contained in this instruction manual might be treated as controlled technology in your countries, due to agreements in international regime for export control.

Please be reminded that export license/permission could be required when this manual is provided, due to export control regulations of your country.

# Safety Instructions

## WARNING

### • Turn off power

Risk of electrical shock. Dismantling/assembling the pump unit without turning off power may cause an electrical shock. Before engaging in any maintenance or inspection work, be sure to turn off the pump and related devices.



Electrical shock

### • For specified application only

The use of the pump in any application other than those clearly specified may result in injury or damage. Use the pump in a specified condition.



Prohibited

### • No modification

Do not modify the pump. We are not responsible for any accidents or damage due to modification.



No remodeling

### • Wear protective clothing

Always wear protective clothing such as safety goggles and protective gloves during pipework or dismantlement.



Wear protectors

### • Specified power only

Do not apply any power other than the specified one on the nameplate. Otherwise damage or fire may result.



Prohibited

## CAUTION

### • Restriction on operators

The pump should be handled by a qualified person with a full understanding.



Prohibited

### • Ventilation

Poisoning may result when handling a toxic or odorous liquid. Keep good ventilation in a working area.



Caution

### • Operating and Storage conditions

Do not install or store the pump:

1. Where ambient temperature falls below  $-10^{\circ}\text{C}$  or exceeds  $60^{\circ}\text{C}$ .
2. Under a flammable/corrosive atmosphere.



Prohibited

### • Countermeasure against efflux

Take protective measures against the accidental efflux caused by bellows and diaphragm breakage.



Caution

### • Do not wet the pump

If a liquid spills over electric parts or wires, a fire or electrical shock may result. Install the pump in a place free from liquid spillage.



Prohibited

# Safety Instructions

## CAUTION

### • Damaged pumps

Do not use any damaged pump. Using a damaged pump may lead to an electric leak or shock.



Prohibited

### • Stop operation

Finding any abnormality, stop operation immediately and inspect/solve problems.



### • Wear part replacement

Observe related instructions for part replacement. Do not dismantle the pump beyond the extent described in this manual.



### • Do not damage a power cable

Risk of fire or electrical shock. Do not scratch, modify, or pull a power cable. The cable can also be damaged when it is heated or loaded with a heavy thing.



Electrical shock

### • Do not place the pump close to water

The pump is not dust-/water-proof construction. The use of the pump in a humid place or a place where the pump can get wet may result in electrical shock or short-circuit.



Prohibited

## CAUTION

### • Damaged power cable

Do not use any damaged power cable for the prevention of a fire or electrical shock. The cable is not replaceable, so that the whole pump unit needs to be replaced when the cable is damaged.



Electrical shock

### • Pump disposal

Dispose of any used or damaged pump in accordance with local laws and regulations (Consult a licensed industrial waste products disposing company.).



# Outline

Before use, check the specification, limitation and hazardous nature of the pump.

## 1. Unpacking & Inspection

On unpacking the product, check the following points. If you find any problems, contact your nearest distributor.

1. Check the information on the nameplate to see that the product is delivered as per order.
2. Check for transit damage, deformation, and loose bolts.

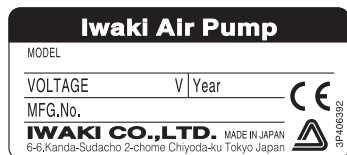

## 2. Operating principle

The BAN-0510/-0505 is a compact bellows type air pump and is designed to be built into a household fuel cell system as a fuel booster or into various analysers, with a speed control BLDC motor, heat-resistant bellows/valves and dual sealing structure.

The rotary motion of the motor is converted through a connecting rod to expansion and contraction of the bellows, in which gas is transferred from the inlet to outlet.

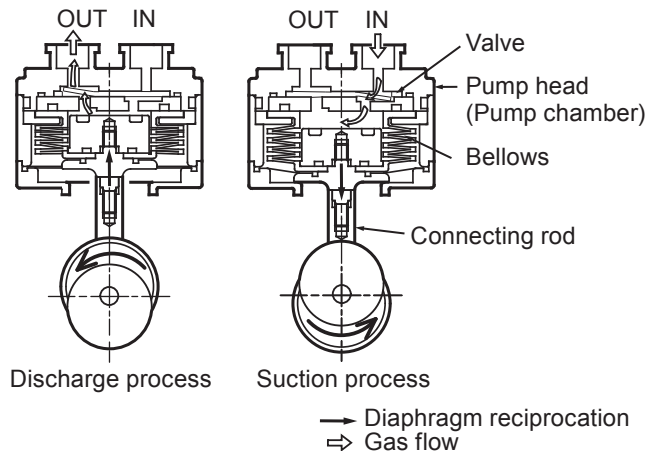

### 3. Identification code

**BAN - 0510 H A Q - D4 - 02**  
                                   a   b   c   d           e    f

- a. Pump size
  - 0510 : 0.05MPa 10L/min
  - 0505 : 0.05MPa 5L/min
- b. Pump head
  - H : Vertically oriented
  - L : Horizontally oriented
- c. Pump head material
  - A : Aluminium
- d. Pump connection
  - Q : Quick fastener
- e. Motor
  - D4 : 24V BLDC motor (with 1-5VDC control signal)
- f. Special specification
  - No code : Standard
  - 01-99 : Special design

### 4. Specifications

#### ■ Pump

Type	Max air flow (L/min)	Max. discharge pressure (MPa)	Max. vacuum (kPa)	Motor		Connection	Quick fastener	Weight (kg)	Lowest starting temp. (°C)
				Power con. (W)	Rated current (A)				
BAN-0510H	10	0.05	54.66	24	1	ø13	1.6	-10	
BAN-0510L									
BAN-0505H	5		67.99	14	0.6				
BAN-0505L									

- NOTE1. Observe the maximum discharge pressure of 0.05MPa.
- NOTE2. Allowable gas temperature range is 0-60°C.
- NOTE3. Allowable ambient temperature range is -10 - 60°C.
- NOTE4. Use screw/band tube clamps (ø13 Quick fastener) to secure tubes to both the inlet and outlet of the pump.

#### ■ Wet end material

Parts	Model	BAN-0510	BAN-0505
Pump head		ADC12	
Bellows		PTFE	
Bellows support		ADC12	
Valve		HNBR	
Valve seat		ADC12	
O ring		NBR	
Screw		SUS304 or equivalent	

- ADC12 : Aluminium die casting
- PTFE : Polytetrafluoroethylene
- HNBR : Hydrogenated Nitrile Butadiene Rubber
- NBR : Nitrile Butadiene Rubber
- SUS304 : Austenite stainless steel

## 5. Outer dimension

■ BAN-0510H/-0505H

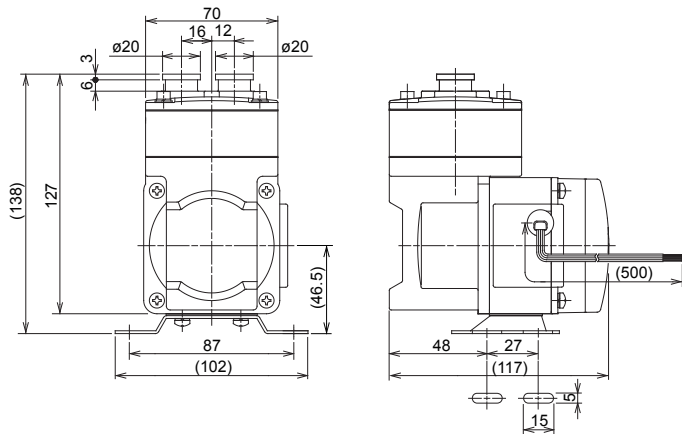

■ BAN-0510L/-0505L

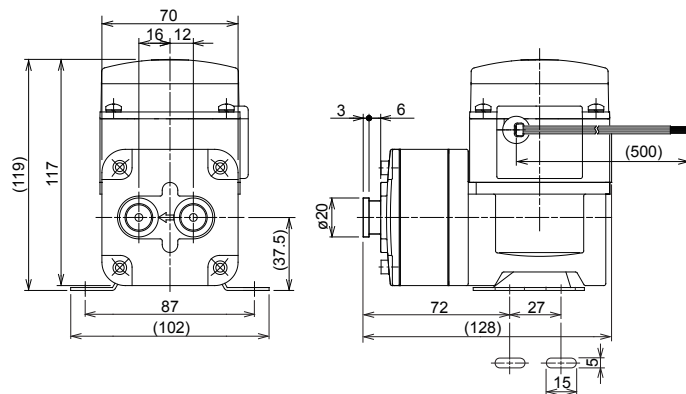

## 6. Performance curve

### ■ BAN-0510

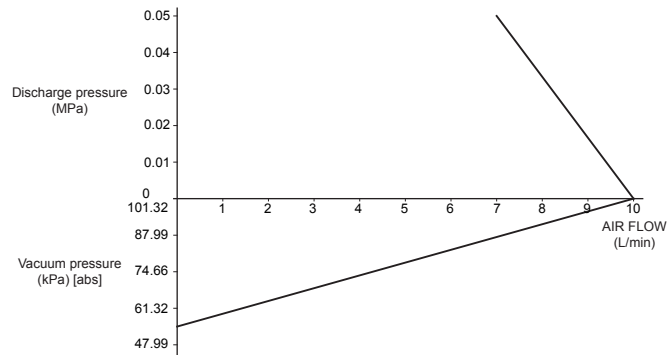

### ■ BAN-0505

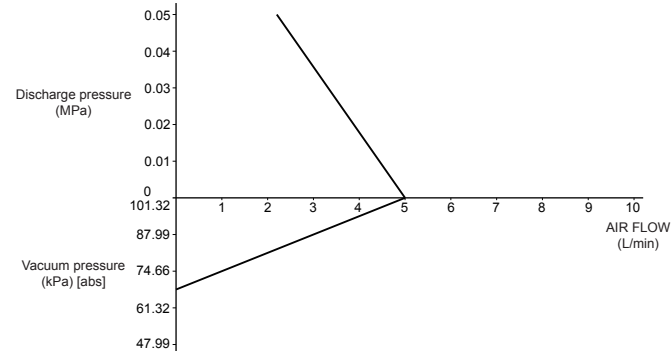

## 7. Overview & Label

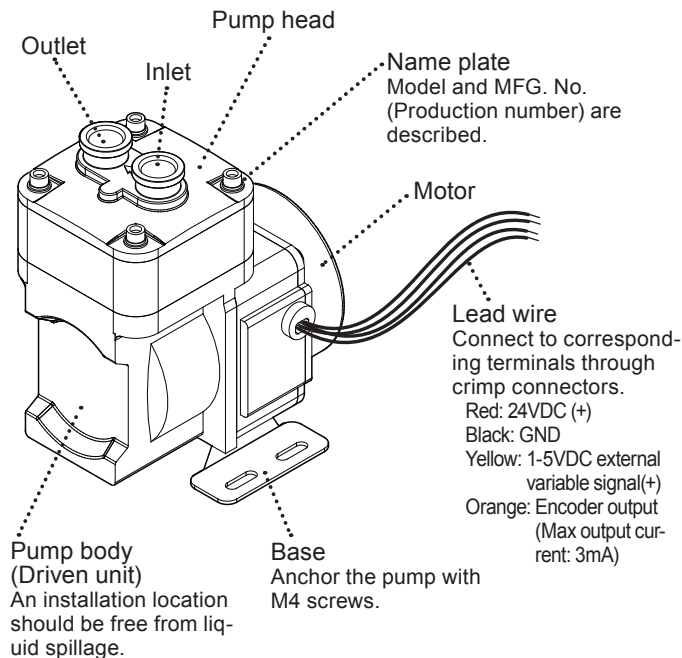

## 8. Part names & Structure

■ BAN-0510/0505

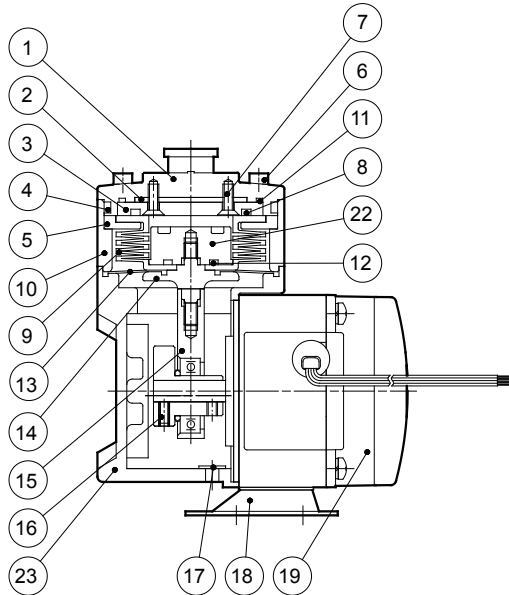

No.	Part names	Q'ty
1	Pump head	1
2	Valve	1
3	Valve seat	1
4	O ring	1
5	Bellows flange A	2
6	Bolt	4
7	Screw	2
8	O ring	1
9	Bellows	1
10	Bracket C	1
11	O ring	1

No.	Part names	Q'ty
12	O ring	1
13	Diaphragm	1
14	Retainer	1
15	Connecting rot unit	1
16	Set screw	2
17	Filter	1
18	Base	1
19	Motor	1
22	Bellows holder A	1
23	Bracket A	1

# Installation

## 1. Before Installation

Read through this instruction manual before use. Carry out installation work with a full understanding.



### CAUTION

- **No fire**  
Keep the pump away from flammable object.
- **Damaged pump**  
Risk of electrical leakage and electrical shock.  
Do not use a damaged pump.

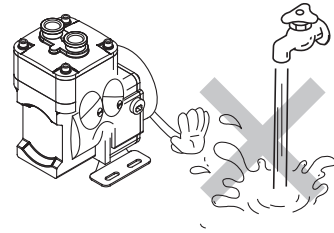

- Do not install the pump in a place where the pump can get wet. Avoid using wet gas, or internal condensation will build up and consequently result in the short lives of valves and bellows.

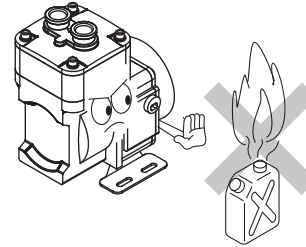

- Do not install the pump in a corrosive or flammable gas atmosphere. Keep good ventilation in a working area.

- Ambient temperature should not fall below  $-10^{\circ}\text{C}$  or exceed  $60^{\circ}\text{C}$ . Observe the allowable gas temperature range of 0 and  $60^{\circ}\text{C}$ .

# Installation

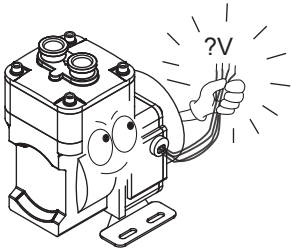

- Observe the rated voltage specified on the name plate. Applying any voltage than the rated one may result in failure.

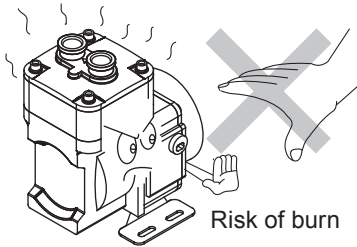

- Surface temperature may rise high in operation but it dose not mean failure. Do not touch the pump body directly or place the objects which may be deformed by heat close to the pump.

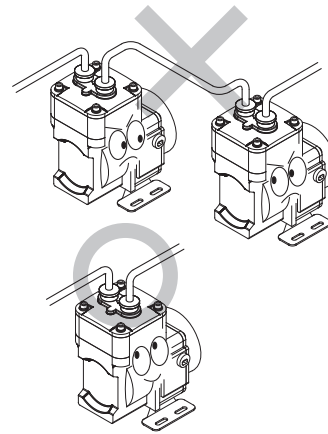

- Do not tube two or more pumps in series. It may prevent the motor from starting and lead to a burn out.

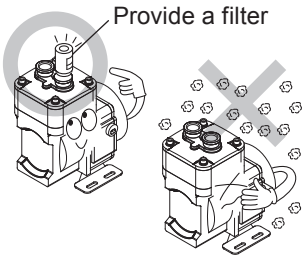

- Do not use the pump in a dusty place. Be sure to provide the inlet with a filter to prevent foreign matters from getting into the pump. Otherwise, the pump performance may reduce or the lives of valves and bellows may remarkably shorten.

# Installation

## 2. Installation/ Tubing/ Electrical wiring

### **WARNING**

Stop working upon sensing danger or abnormality.

### 2.1 Installation

1. Do not expose the pump to direct sunlight, vibration and wind & rain.
2. Keep good ventilation. The pump should always be free from the possibility of getting wet.
3. Ambient temperature should not fall below  $-10^{\circ}\text{C}$  or exceed  $60^{\circ}\text{C}$ . Observe the allowable maximum ambient humidity of 90%RH.
4. Install the pump in a clear and level place.  
Select a convenient place for maintenance and inspection.

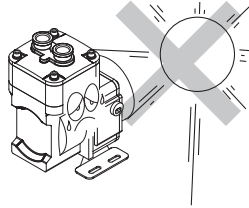

### 5. Pump fixation

Set the pump baseplate on a concrete foundation and fasten M4 anchor bolts tightly to prevent the pump from vibrating during operation.

### **CAUTION**

**Do not install the pump on a unstable place.**

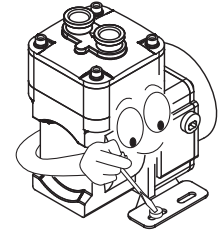

### 2.2 Tubing

1. The short tubing with the minimum bends is optimal to reduce resistance.
2. Avoid sharp turns or bends.

### **CAUTION**

**Do not have tubing bent or pressed. Otherwise, the tube end may break.**

3. Select temperature- and pressure-resistant discharge and suction line tubes according to gas to be handled. Use screw/band tube clamps ( $\varnothing 13$  Quick fastener) to secure tube connection.

# Installation

## 4. Valve installation

Install valves on both discharge and suction lines.

- Suction valve:

For adjustment of an air flow and a vacuum.

- Discharge valve:

For maintenance and shutoff.

### ■ Quick fastener connection

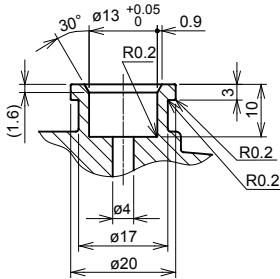

## 2.3 Electrical wiring

*Electrical wiring must be performed by a qualified electrician. We are not responsible for personal injury or property damage due to nonobservance of this warning. Contact us or your nearest distributor for wiring as necessary.*

### ■ Before wiring

1. Confirm that power is disconnected before work.
2. Wiring work should be done in accordance with local electrical codes. Use the recommended wiring accessories.
3. Observe the rated voltage specified on the name plate.
4. When an external fuse is used and has blown out, always investigate and solve root causes. Replace the fuse before resuming operation.  
Be sure to unplug the pump before investigating the cause of blowout. If the fuse blows frequently, starting current may be a root cause. In this case review the system.

# Installation

5. For wire lead colours, red ⊕ and black ⊖ are for power voltage. Yellow ⊕ and black ⊖ leads are for external variable signal. The black ⊖ lead is common for both the power and the signal. Observe the maximum signal voltage of 5.5VDC.

## ⚠ CAUTION

**Observe polarity, otherwise failure or malfunction may result. Note that rotational direction of the motor does not change by reversing polarity.**

Red: 24VDC (+)

Black: GND (-)

Yellow: 1-5VDC external variable signal(+)

Orange: Encoder output (Max output current: 3mA)

6. In order to make ON-OFF operation, install a switch between the DC power supply and the pump. Installing it between the DC power supply and the AC power source, the pump may not run.

7. After wiring work, check that the system is free from the inductive noise at start-up.
8. Noise accompanies the high-speed switching of the drive circuit. Check it does not affect peripheral devices.
9. If a power source is shared with inductive loads such as a solenoid relay, take protective measures against surge.

## ■ Rated current & Starting current

Model	Rated current	Starting current
BAN-0510	1A	4A or below
BAN-0505	0.6A	4A or below

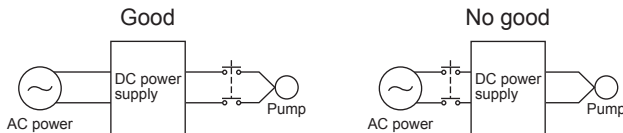

Wiring example

# Operation

## 1. Before operation

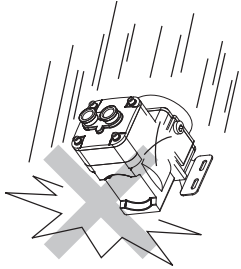

- Dropping or subjecting the pump to strong impact, failure may result. Handle the pump with care.

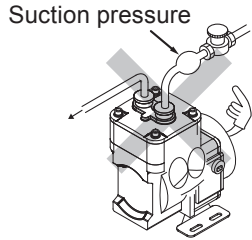

Suction pressure

- The pump can not start with full discharge/suction pressure. Remove pressure before operation.

No load operation

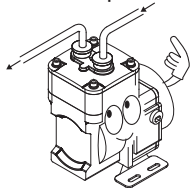

- After a long period of stoppage, pump performance at the beginning of operation becomes occasionally unstable. In this case, warm the pump up for 10 minutes with no discharge line pressure.

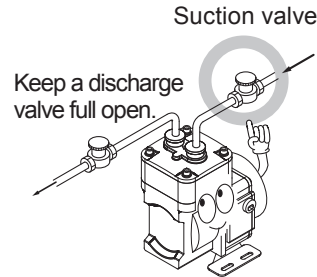

Suction valve

Keep a discharge valve full open.

- Always use a suction valve to adjust an air flow. Observe the maximum discharge pressure of 0.05MPa.

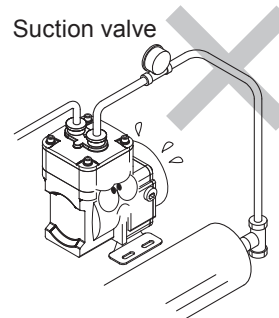

Suction valve

Do not increase suction-line pressure

- If the compressed air or liquid (higher pressure than atmospheric pressure) is transferred to the pump, the lives of the valves, bellows and bearing may be sharply reduced. Always keep atmospheric or lower pressure in the suction line.

- Do not use solvents such as benzene, alcohol, thinner for maintenance or cleaning, otherwise a coat discolours or comes off.

# Operation

## 2. Pump operation

### ■ Start-up

1. Before pump operation, check that each tube connection is secured.
2. Check that a suction line is connected to the inlet and a discharge line to the outlet.

### CAUTION

**If a suction line and a discharge line are connected the other way around, pumping process is inverted.**

3. Check that the pump is firmly fixed on a mounting position.

### ■ Operation

Operate the pump according to the following steps.

No.	Procedure	Points to be Checked
1	Check tubing, wiring and voltage.	<ul style="list-style-type: none"><li>• See "2.2 Tubing" and "2.3 Electrical wiring" sections.</li><li>• Check the spec label to see if power supply voltage is correct.</li></ul>
2	Open valves.	<ul style="list-style-type: none"><li>• Fully open both discharge and suction lines.</li></ul>
3	Supply power to the pump.	<ul style="list-style-type: none"><li>• Check the item 1 and 2. Then turn on power and start the pump.</li><li>• Smooth starting may not be obtained when ambient temperature is 10°C or below. In this case, run the pump with no discharge line pressure for a few minutes to warm it up.</li></ul>
4	Adjust air flow.	<ul style="list-style-type: none"><li>• Provide a running-in period before full scale operation.</li><li>• Always adjust an air flow by a suction valve.</li></ul>

# Operation

5	Points to be checked during operation	<ul style="list-style-type: none"><li>• After starting, check a pressure gauge to see if suction and discharge line pressure are correct and an air flow meter to see if the specified air flow is obtained.</li><li>• Keep a suction line pressure at or below atmospheric pressure.</li><li>• In case electric power has failed while the pump is running, switch off main power. Otherwise, the motor may not restart or may burn out depending on a line pressure at the time of power recovery.</li></ul>
---	---------------------------------------	--

## ■ Stop and Storage

Before a long period of stoppage (1 week or more):

- Release pressure and turn off main power.
- Make sure both supply air and gas are stopped.

Before resuming operation:

- Warm up the pump under no load operation. Operation may occasionally be upset in the beginning.
- Follow the "■ Operation" table to resume operation.

# Maintenance

## 1. Trouble shooting

Turn off power on sensing danger and check the following. In case trouble can not be solved, contact us or your nearest distributor.

Phenomenon					Measures
Causes	Pump does not run.	Pump stops running.	Poor air flow or discharge pressure	Pump makes noise.	
No power distribution	<input type="radio"/>	<input type="radio"/>	<input type="radio"/>	<input type="radio"/>	Check wiring.
Motor trouble (disconnection or capacitor failure)	<input type="radio"/>	<input type="radio"/>	<input type="radio"/>	<input type="radio"/>	Replace the motor.
Wrong tubing or poor connection	<input type="radio"/>	<input type="radio"/>	<input type="radio"/>	<input type="radio"/>	Check and fix tubing.
Pump head mounting screws are loose.	<input type="radio"/>	<input type="radio"/>	<input type="radio"/>	<input type="radio"/>	Tighten the screws.
Bellows holder is loose.	<input type="radio"/>	<input type="radio"/>	<input type="radio"/>	<input type="radio"/>	Tighten the holder.
Bellows is damaged.	<input type="radio"/>	<input type="radio"/>	<input type="radio"/>	<input type="radio"/>	Replace bellows.*
Filter is clogged.	<input type="radio"/>	<input type="radio"/>	<input type="radio"/>	<input type="radio"/>	Remove foreign matters.
Valves are worn.	<input type="radio"/>	<input type="radio"/>	<input type="radio"/>	<input type="radio"/>	Replace valves.*
Higher suction pressure than atmospheric	<input type="radio"/>	<input type="radio"/>	<input type="radio"/>	<input type="radio"/>	Reduce suction pressure.
Eccentric shaft has worn.	<input type="radio"/>	<input type="radio"/>	<input type="radio"/>	<input type="radio"/>	Replace the connecting rod unit.
Connecting rod bearing has worn.	<input type="radio"/>	<input type="radio"/>	<input type="radio"/>	<input type="radio"/>	Replace the connecting rod unit.
Motor bearing has worn.	<input type="radio"/>	<input type="radio"/>	<input type="radio"/>	<input type="radio"/>	Replace the motor.
Voltage reduction	<input type="radio"/>	<input type="radio"/>	<input type="radio"/>	<input type="radio"/>	Increase voltage to the rated level.
Bracket tightening screws are loose.	<input type="radio"/>	<input type="radio"/>	<input type="radio"/>	<input type="radio"/>	Secure them.
Condensation in the pump head.	<input type="radio"/>	<input type="radio"/>	<input type="radio"/>	<input type="radio"/>	Dry up the pump.

Contact us for the measures marked with \*.

## 2. Maintenance & Inspection

Handling of the pump, maintenance and inspection should be carried out within the descriptions of this instruction manual.

We are not responsible for personal injury or property damage due to nonobservance of this warning. Contact us or your nearest distributor as necessary.

### ■ Daily inspection

Pay attention to the following items during operation. Stop operation on sensing danger and solve problems on the trouble shooting section. If pump performance has remarkably reduced, replace wear parts.

No.	Check that...	Measure
1	pump operation is normal.	<ul style="list-style-type: none"> <li>Apply correct voltage and amperage.</li> <li>Adjust discharge/suction pressure.</li> </ul>
2	there is no noise or vibration problem.	<ul style="list-style-type: none"> <li>Unusual noise/vibration may occur when pump operation is not normal.</li> </ul>
3	there is no air leak or air ingress from pump parts and tubing connections.	<ul style="list-style-type: none"> <li>Retighten connections.</li> </ul>

# Maintenance

## ■ Ware parts

Replace the valve in the pump head and related O rings when performance has remarkably reduced.

The durability of these wear parts varies according to the pressure, temperature and character of gas.

## ■ Cleaning

Turn off power and wait until the pump has cooled down. Then clean off the surface of the pump with a wet cloth. Use a neutral detergent for greasy dirt as necessary and dry it with a dry cloth.

Check the pump surface has dried up before operation.

### CAUTION

**Risk of electrical shock. Do not wet electric parts or wiring.**

## ■ Storage

Protect the pump from dust during storage.

Do not store the pump in the following places where...

- Ambient temperature falls below -10°C or exceeds 60°C.
- Under a flammable or corrosive atmosphere.
- Under heavy dust or high humidity.
- Under direct sunlight or wind & rain.
- Under vibration.

## 3. Wear part replacement

***For a long period of operation wear parts need to be replaced periodically.***

### CAUTION

#### ● Turn off power before service

Risk of electrical shock. Be sure to turn off power to stop the pump and related devices before service is performed.

#### ● Do not touch the pump or pipe with bare hands

Risk of burning. The surface temperature of the pump or pipe gets high in or right after operation.

#### ● Wear protective clothing

Always wear protective clothing such as an eye protection, chemical resistant gloves, a mask and a face shield during disassembly, assembly or maintenance work.

See page 7 "**8. Part names & Structure**" as necessary.

# Maintenance

## ■ Valve replacement

1. Unscrew the pump head fixing bolts and take out the pump head unit and O rings.
2. Loosen two screws beneath the unit and take it apart into the pump head, O rings, valve and valve seat.
3. Replace worn valve and O rings with new ones and put them together. Apply LOCTITE® 222 to the screws and tighten them by  $1.47\text{N}\cdot\text{m}$ .
4. Push down the bellows holder A to retract the bellows. Mount and secure the unit onto the Bracket C with the fixing bolts. Tightening torque is  $1.47\text{N}\cdot\text{m}$ .

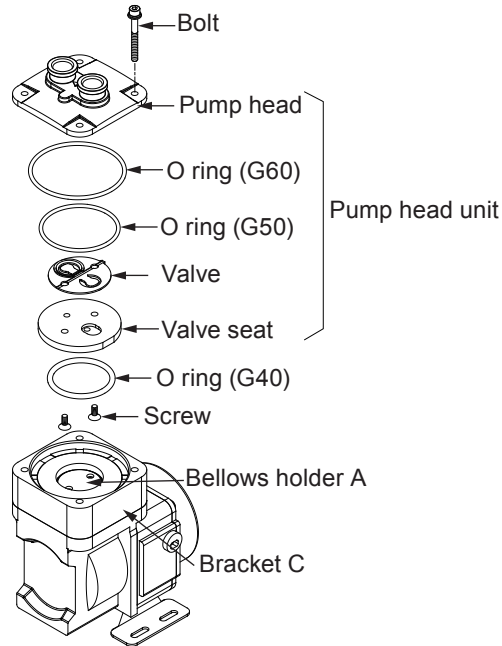









( )Country codes  
**IWAKI CO.,LTD.** 6-6 Kanda-Sudacho 2-chome Chiyoda-ku Tokyo 101-8558 Japan  
 TEL:(81)3 3254 2935 FAX:3 3252 8892(<http://www.iwakupumps.jp>)

<b>Australia</b>	<b>IWAKI Pumps Australia Pty. Ltd.</b>	TEL: (61)2 9899 2411	FAX: 2 9899 2421	<b>Italy</b>	<b>IWAKI Europe GmbH, Italy Branch</b>	TEL: (39)0444 371115	FAX: 0444 335350
<b>Austria</b>	<b>IWAKI EUROPE GmbH</b>	TEL: (49)2154 92540	FAX: 2154 925448	<b>Korea</b>	<b>IWAKI Korea Co.,Ltd.</b>	TEL: (82)2 2630 4800	FAX: 2 2630 4801
<b>Belgium</b>	<b>IWAKI Belgium n.v.</b>	TEL: (32)1367 0200	FAX: 1367 2030	<b>Malaysia</b>	<b>IWAKIm Sdn. Bhd.</b>	TEL: (60)3 7803 8807	FAX: 3 7803 4800
<b>China</b>	<b>IWAKI Pumps (Shanghai) Co., Ltd.</b>	TEL: (86)21 6272 7502	FAX: 21 6272 6929	<b>Norway</b>	<b>IWAKI Norge AS</b>	TEL: (47)23 38 49 00	FAX: 23 38 49 01
<b>China</b>	<b>IWAKI Pumps (Guangdong) Co., Ltd.</b>	TEL: (86)750 3866228	FAX: 750 3866278	<b>Singapore</b>	<b>IWAKI Singapore Pte. Ltd.</b>	TEL: (65)6316 2028	FAX: 6316 3221
<b>China</b>	<b>GFTZ IWAKI Engineering &amp; Trading (Guangzhou)</b>	TEL: (86)20 8435 0603	FAX: 20 8435 9181	<b>Spain</b>	<b>IWAKI Europe GmbH, Spain Branch</b>	TEL: (34)93 37 70 198	FAX: 93 47 40 991
<b>China</b>	<b>GFTZ IWAKI Engineering &amp; Trading (Beijing)</b>	TEL: (86)10 6442 7713	FAX: 10 6442 7712	<b>Sweden</b>	<b>IWAKI Sverige AB</b>	TEL: (46)8 511 72900	FAX: 8 511 72922
<b>Denmark</b>	<b>IWAKI Nordic A/S</b>	TEL: (45)48 24 2345	FAX: 48 24 2346	<b>Switzerland</b>	<b>IP Service SA</b>	TEL: (41)26 674 9300	FAX: 26 674 9302
<b>Finland</b>	<b>IWAKI Suomi Oy</b>	TEL: (358)9 2745810	FAX: 9 2742715	<b>Taiwan</b>	<b>IWAKI Pumps Taiwan Co., Ltd.</b>	TEL: (886)2 8227 6900	FAX: 2 8227 6818
<b>France</b>	<b>IWAKI France S.A.</b>	TEL: (33)1 69 63 33 70	FAX: 1 64 49 92 73	<b>Taiwan</b>	<b>IWAKI Pumps Taiwan (Hsin-chu) Co., Ltd.</b>	TEL: (886)3 573 5797	FAX: (886)3 573 5798
<b>Germany</b>	<b>IWAKI EUROPE GmbH</b>	TEL: (49)2154 9254 0	FAX: 2154 9254 48	<b>Thailand</b>	<b>IWAKI (Thailand) Co.,Ltd.</b>	TEL: (66)2 322 2471	FAX: 2 322 2477
<b>Holland</b>	<b>IWAKI Europe GmbH, Netherlands Branch</b>	TEL: (31)74 2420011	FAX: 2154 9254 48	<b>U.K.</b>	<b>IWAKI Pumps (UK) LTD.</b>	TEL: (44)1743 231363	FAX: 1743 366507
<b>Hong Kong</b>	<b>IWAKI Pumps Co., Ltd.</b>	TEL: (852)2 607 1168	FAX: 2 607 1000	<b>U.S.A.</b>	<b>IWAKI AMERICA Inc.</b>	TEL: (1)508 429 1440	FAX: 508 429 1386
<b>Indonesia</b>	<b>IWAKI Singapore (Indonesia Branch)</b>	TEL: (62)21 690 6606	FAX: 21 690 6612	<b>Vietnam</b>	<b>IWAKI pumps Vietnam Co.,Ltd.</b>	TEL: (84)613 933456	FAX: 613 933399