

IWAKI
Magnetic Drive Pump

MD SERIES

Instruction Manual

 Read this manual before use of product

Thank you for having selected the Iwaki Magnetic Drive Pump MD series. This manual deals with the correct handling and operation procedures and troubleshooting methods for the pump. To make maximum use of the pump and to ensure safe, long operation, please read this manual carefully prior to operating the pump. Pay special attention to the “Warning” and “Caution” sections as they relate to matters of safety and proper usage of the pump.



Contents

Chapter	Page
1. Safety Instruction	1, 2
2. Unpacking and Inspection	3
3. Operating Principle	3
4. Identification Codes	4,5
5. Specifications	6, 7
6. Outer Dimensions and Performance Curve.....	8 ~ 13
7. Main Parts and Label	14
8. Name of Parts	15
9. Handling	16 ~ 18
10. Installation, Piping, and Wiring	19 ~ 23
11. Operation	24 ~ 26
12. Causes of Trouble and Troubleshooting	27

Important Instruction

For the Safe and Correct Handling of the Pump

- Read the “Safety Instructions” sections carefully to prevent accidents involving your customers or other personnel and to avoid damage or loss of other assets. Always follow the instructions and advice found in these sections.
- Observe and abide by the instructions described in this manual. These instructions are very important for protecting pump users from dangerous conditions and situations related with the use of the pump system.
- The symbols relate to the following meanings described below:

 Warning	Nonobservance or misapplication of the contents of the “Warning” section could lead to a serious accident, including death or injury.
 Caution	Nonobservance or misapplication of the contents of the “Caution” section could lead to serious physical injury to the user or serious damage to the product.

Types of Symbols



Indicates that “Warning” or “Caution” must be exercised. Inside this triangle, a concrete and practical image provided as a warning or caution message is depicted.



Indicates a prohibited action or procedure. Inside or near this circle, a concrete and practical image of the activity to be avoided is depicted.



Indicates an important action or procedure which must be performed or carried out without fail. Failure to follow the instructions herein can lead to malfunction or damage to the pump.

1. Safety Instruction

Warning

Turn off the power supply.

Working without disconnecting the power supply may cause an electrical shock. Before engaging upon any working procedures involving the pump, make sure to turn the power supply switch off and to stop the pump and other related devices.



Electrical Shock

Terminate operation.

When you detect or become aware of a dangerous sign or abnormal condition during operation, terminate the operation immediately and start it from the beginning again.



For specified application only.

The use of a pump in an application other than those clearly specified may result in injury or damage to the pump. Use the pump strictly in accordance with the pump specifications and application range.



Prohibited

No remodeling.

Never remodel a pump. Otherwise, a serious accident may result. Iwaki will not be responsible for any accident or damage of any kind which is caused by the user remodeling the pump without first obtaining permission or instructions from Iwaki.



No Remodeling

Wear protectors.

If you touch or come in contact with any type of hazardous chemical liquid, including but not limited to chemicals, you may experience a serious injury. Wear protective gear (protective mask, gloves, etc.) during the pump operation.



Wear protective gear

Caution

Qualified operators only.

The pump operator and pump operation supervisor must not allow any operators who have little or no knowledge of the pump to run or operate the pump. Pump operators must have a sound knowledge of the pump and its operation.



Prohibited

Specified power only.

Do not operate the pump on voltage which is not specified on the nameplate. Failure to do so may result in damage or fire. Only the specified power level is to be applied.



Prohibited

Do not wet or dampen.

If the motor or wiring cable becomes wet or dampened with the operating liquid by mistake, this may result in a fire or cause an electrical shock. Install the motor and wiring cable in positions which are not likely to become wet or dampened with any liquid.



Prohibited

Ventilate.

Poisoning may result during an operation which involves toxic or odorous liquid. Ventilate the operating site sufficiently.



Caution

Spill-out accident.

Protective measures should be taken against any accidental spill-out or leakage of the operating liquid as a result of unexpected damage on the pump or the related piping.



Caution

Caution

Operating site must be free of water and humidity.

The pump is not designed to be water-proof or dust-proof. The use of the pump in places where water splashes or humidity is high may result in an electrical shock or short circuit.



Prohibited

Do not damage power cable.

Do not scratch, damage, process, or pull the power cable forcibly. An extra load onto the cable, such as heating the cable or placing something heavy on the cable, may damage the cable and finally cause a fire or an electrical shock.



Caution

Do not cover the motor.

Running a covered motor may accumulate heat inside the motor and cause a fire or a mechanical failure. Ventilate the motor sufficiently.



Arrange grounding.

Do not operate the pump without connecting the grounding wire. Otherwise, an electrical shock may result. Make sure the grounding wire is connected with the grounding terminal.



Grounding

Install an earth leakage breaker (option).

The operation of a pump without using an earth leakage breaker may cause an electrical shock. Please purchase an optional leakage breaker and install in the system.



Electrical Shock

Caution

Power cable cannot be replaced.

Never use a damaged or affected power cable. Otherwise, a fire or an electrical shock may result. Handle the power cable carefully, as it cannot be replaced by a new cable. (The complete motor must be replaced in that circumstance.)



Caution

Limited operating site and storage.

Do not install or store the pump in the following places:
* Places where a flammable gas or material is used or stored.
* Places where the ambient temperature is extremely high (40°C or higher) or extremely low (0°C or lower).



Prohibited

Do not drain the liquid in the site.

The liquid discharged out of the pump, including a hazardous chemical liquid, must be drained into a special container. Never drain such liquid directly onto the floor in or near the operation site.



Prohibited

Disposal of used pump.

Disposal of used or damaged pumps must be done in accordance with the relevant local laws and regulations. (Consult a licensed industrial waste products disposing company.)



Countermeasure for static electricity.

When low electric conductivity liquid such as ultra-pure water and flour inactive liquid (e.g. Fluorinert™) are handled, the static electricity may be generated in pump, which may cause static discharge and break down of pump. Take countermeasure to avoid and remove static electricity.



2. Unpacking and Inspection

After unpacking the product, check the following points.

- [1] Do the model, flow and head indicated on the nameplate correspond with your order?
- [2] Has the pump or any part of it been damaged as a result of accident or handling during shipment?

Iwaki Magnet Pump 		
MODEL		
MAX.CAPACITY		•/min
MAX.HEAD		m
▽		
RATED VOLTAGE		V
RATED POWER CONSUMPTION		W
RATED FREQUENCY		Hz
INDOOR	MAX.LIQUID TEMP.80	
SINGLE PHASE (1φ) INDUCTION MOTOR		
CAPACITOR-RUN		
POLES	SPEED	rpm
VOLTAGE	V RATING	CONT.
FREQUENCY	Hz	CAPACITOR μF
CURRENT	A	INSULATION CLASS E
OUTPUT	W	
⚠ DO NOT RUN PUMP DRY		
MFG.No.		
IWAKI CO.,LTD. TOKYO JAPAN		

If you find any discrepancy, please contact your dealer.

3. Operating Principle

The centrifugal pump is driven by pair of magnets which are incorporated in the impeller and motor shaft. The sealless pump structure eliminates shaft seals such as conventional mechanical seals because the pump chamber is shielded by the casings and the impeller is operated by the magnets. The combined coupling torque of the drive magnet and impeller magnet gives sufficient driving power against the motor torque.

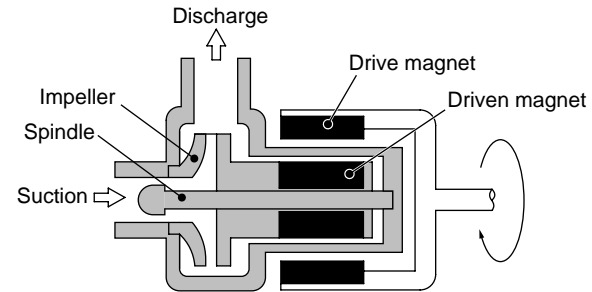

4. Identification Codes

		<div style="display: flex; justify-content: space-around; align-items: center;"> <div style="text-align: center;">① MD - 20R</div> <div style="text-align: center;">② X</div> <div style="text-align: center;">③ M</div> <div style="text-align: center;">-</div> <div style="text-align: center;">④ 220</div> <div style="text-align: center;">⑤ E</div> <div style="text-align: center;">⑥ N</div> <div style="text-align: center;">⑦ 01</div> </div>
1	Series type	MD-15R, MD-20R, MD-30R, MD-40R, MD-55R
2	Pump type	X: High flow rate type Z: High head type No symbol: Standard type
3	Suction/discharge port type	M: Threaded connection No symbol: Hose connection
4	Power source voltage	220: 220/240V(50/60Hz) 230: 230V (50/60Hz)
5	O ring material	E: EPDM No symbol: FKM
6	Motor type	N: New type motor
7	Special spec. symbol	01~99: Specially designed specifications No symbol: Standard model

5. Specifications

50/60Hz

Model	Port size (mm)		Threaded connection		Max. flow rate (l/min)	Max. head (m)	Max. specific gravity of liquid	Motor		Mass (kg)
	Suction port	Discharge port	Suction/Discharge	Union (see P13)				Power source voltage (V)	Rated output (W)	
MD-15R(M)	14	14	G 3/4	13	16/19	2.4/3.4	1.3	220/240 Single-phase	10	1.6
MD-20R(M)	18	18		16	27/31	3.1/4.3	1.1		20	2.0
MD-20RX(M)	26	26	G1	20	46/52	1.8/2.5	1.3		45	4.0
MD-20RZ(M)	18	18	G 3/4	13	10/11	4.9/6.9	1.1			
MD-30R(M)	20	20		16	32/38	3.8/5.4	1.3		65	3.9
MD-30RX(M)	26	26	G1	20	62/72	2.9/4.1	1.1			
MD-30RZ(M)	18	18	G 3/4	13	15/17	8/11	1.0			
MD-40R(M)	20	20		16	45/52	4.6/6.5	1.1			
MD-40RX(M)	26	26	G1	20	75/85	3.3/4.7	1.1		90	5.4
MD-40RZ(M)	22	22	G 3/4	16	22/22	10/13.5	1.1			
MD-40RZ-5(M)	22	22		16	12/ –	11.5/ –	1.1			
MD-55R(M)	26	26	G1	20	60/70	5.6/8.2	1.2		90	5.4
MD-55R-5(M)					70/ –	8.2/ –	1.2			

50/60Hz

Model	Port size (mm)		Threaded connection		Max. flow rate (l/min)	Max. head (m)	Max. specific gravity of liquid	Motor		Mass (kg)
	Suction port	Discharge port	Suction/Discharge	Union (see P13)				Power source voltage (V)	Rated output (W)	
MD-70R(M)	26	26	G1	20	86/97	6.7/9.7	1.0	220/240 Single-phase or 220/380 3-phase 400/440 3-phase	150/180	6.0
MD-70RZ(M)	20	20	G 3/4	16	40/43	14.3/20.3	1.0		180/216	6.0
MD-100R(M)	26	26	G1	20	120/135	8.6/11.9	1.2	225/265	8.5	
MD-100R-5(M)					135/ –	11.7/ –	1.1			

Note:

1. Pump performance data is based on pumping clean water at amb. temp.
2. The maximum flow rate is at 0 discharge head.
3. Maximum viscosity of liquid: 0.03 Pa•s (for a specific gravity of 1.0)
4. Permissible liquid temperature: 0~80°C

(When IWAKI option union is used, the liquid temp. is limited to 0~55°C. Also, the permissible temperature may differ depending upon the type of liquid and operating conditions.)

5. The maximum specific gravity of the liquid is the value at max. flow rate.

The value varies depending on the flow rate, ambient temperature, viscosity of liquid, etc.

6. Motor: Single-phase capacitor-run induction motor or 3-phase induction motor.

* Built-in thermal protector

A thermal protector is built in the motor. The device automatically stops motor operation when the motor is overheated. (The motor starts again the operation when the temperature falls to normal.)

6. Outer Dimensions and Performance Curve

Outer dimensions

- MD-15RM, 20RM, 30RM and 40RM types

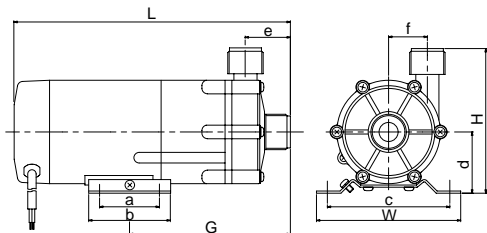

Model	W	H	L	a	b	c	d	e	f	G
MD-15RM	95	114	180	-	50	68	55	39	21.5	117
MD-20RM	85	116	203	30	50	68	55	33	28.5	126
MD-30RM	120	130	248	40	64	100	60	48	31	169
MD-40RM	120	130	250	40	64	100	60	48	31	169

- MD-20RXM, 30RXM and 40RXM types

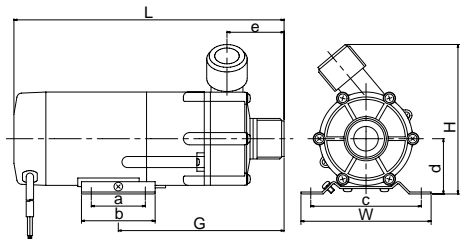

Model	W	H	L	a	b	c	d	e	G
MD-20RXM	85	132	220	30	50	68	55	46.5	143
MD-30RXM	120	140	254	40	64	100	60	50	175
MD-40RXM	120	140	256	40	64	100	60	50	175

- MD-15R, 20R, 30R and 40R types

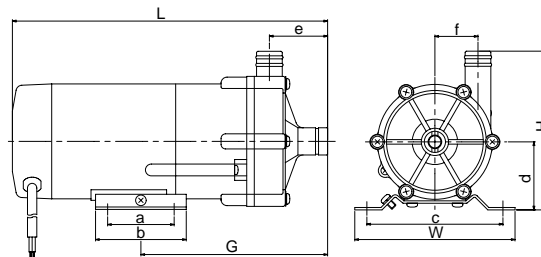

Model	W	H	L	a	b	c	d	e	f	G
MD-15R	95	109	179.5	-	50	68	55	39	21.5	117
MD-20R	85	115	208.5	30	50	68	55	38.5	28.5	131.5
MD-30R	120	130	248	40	64	100	60	48	31	169
MD-40R	120	130	250	40	64	100	60	48	31	169

• MD-20RX, 30RX, and 40RX types

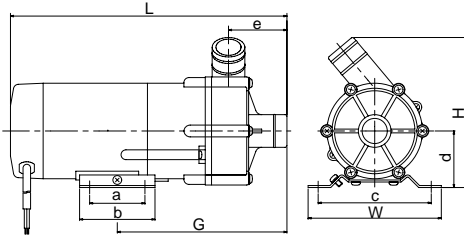

Model	W	H	L	a	b	c	d	e	G
MD-20RX	85	132	220	30	50	68	55	46.5	143
MD-30RX	120	137	254	40	64	100	60	50	175
MD-40RX	120	137	256	40	64	100	60	50	175

• MD-20RZ, 30RZ, 40RZ and 40RZ-5 types

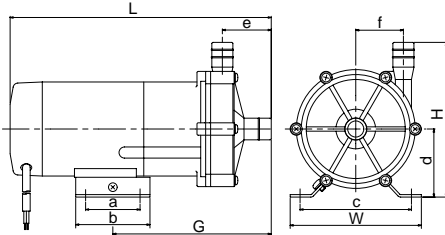

Model	W	H	L	a	b	c	d	e	f	G
MD-20RZ	85	125	211	30	50	68	55	39.5	38.5	134
MD-30RZ	120	130	230	40	64	100	60			152
MD-40RZ	120	150	241	40	64	100	60	38.5	44.5	128
MD-40RZ-5	120	150	241	40	64	100	60	38.5	44.5	128

• MD-55R and 55R-5 types

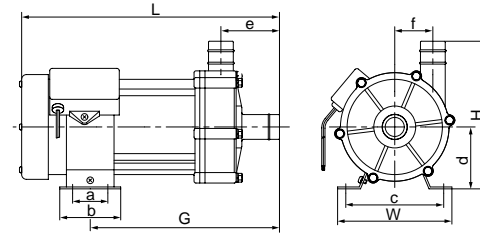

Model	W	H	L	a	b	c	d	e	f	G
MD-55R	120	155	273.5	40	64	100	65	61.5	40	198.5
MD-55R-5										

• MD-20RZM, 30RZM, 40RZM and 40RZ-5M types

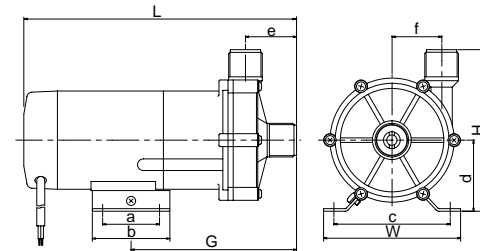

Model	W	H	L	a	b	c	d	e	f	G
MD-20RZM	85	125	211	30	50	68	55	39.5	38.5	134
MD-30RZM	120	130	230	40	64	100	60			152
MD-40RZM	120	150	241	40	64	100	60	38.5	44.5	128
MD-40RZ-5M	120	150	241	40	64	100	60	38.5	44.5	128

• MD-55RM and 55R-5M types

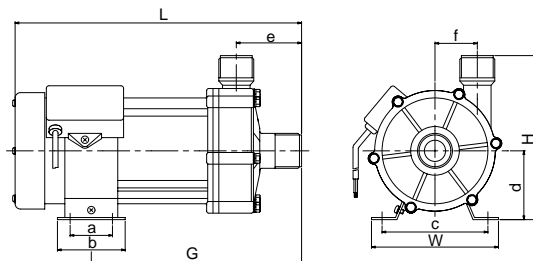

Model	W	H	L	a	b	c	d	e	f	G
MD-55RM	120	155	273.5	40	64	100	65	61.5	40	198.5
MD-55R-5M										

• MD-70R, 70RZ, 100R and 100R-5 types

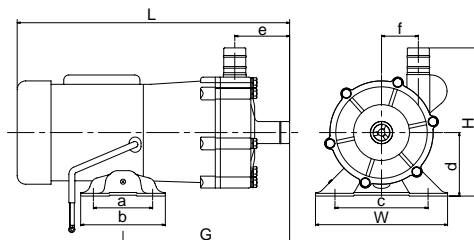

Model	W	H	L	a	b	c	d	e	f	G
MD-70R	130	155	258	40	60	110	65	53	43	179
MD-70RZ										
MD-100R	156	175	322	70	100	110	75	65	43.5	197
MD-100R-5										

• MD-70RM, 70RZM, 100RM and 100R-5M types

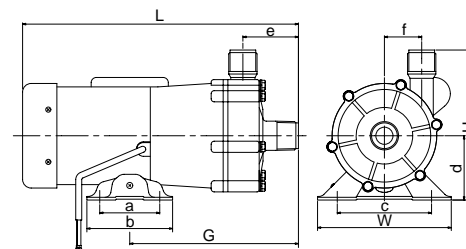

Model	W	H	L	a	b	c	d	e	f	G
MD-70RM	130	155	258	40	60	110	65	53	43	179
MD-70RZM										
MD-100RM	156	175	322	70	100	110	75	65	43.5	197
MD-100R-5M										

Standard Performance Curve
(Pumping clean water at room temperature)

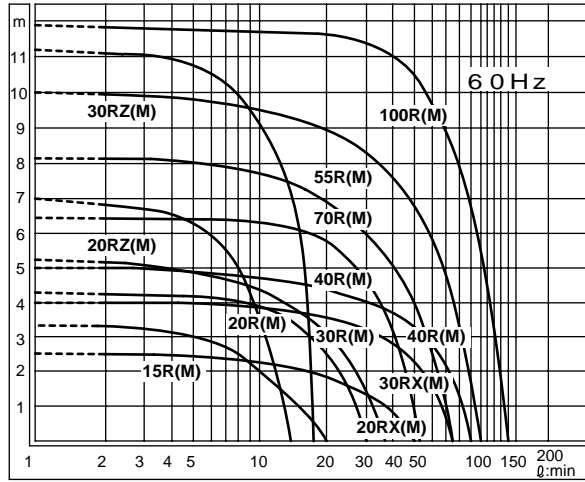
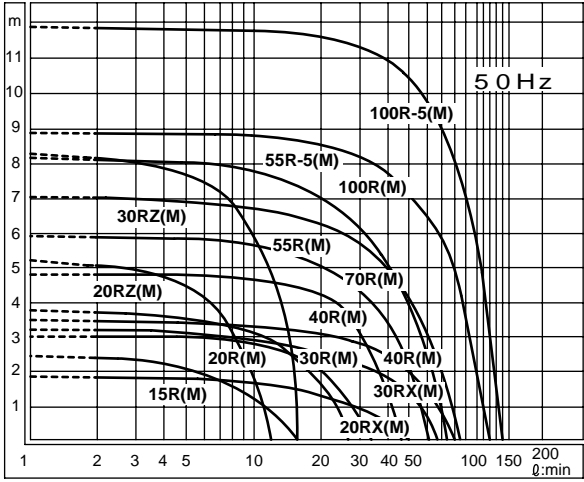

• MD-70RZ(M) types

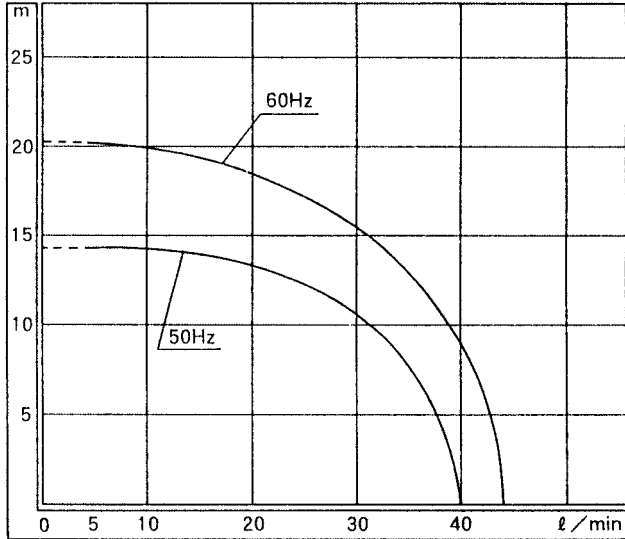

• MD-40RZ(M) types

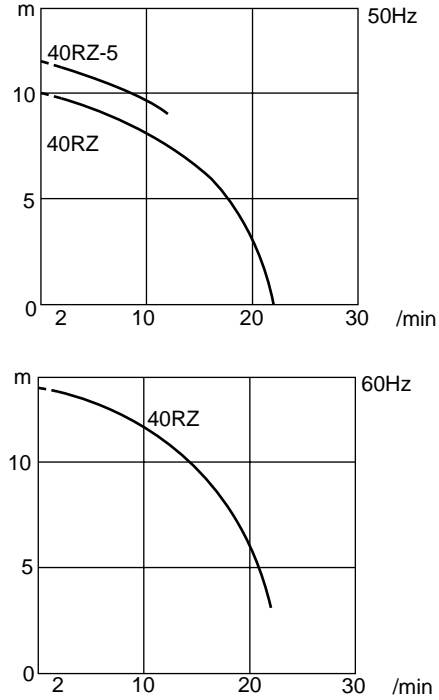

* MD-40RZ(M) makes water disturbing noise when used at discharge head lower than 6m at 50Hz and 7.5m at 60Hz

Special accessories

The following union insets are available as components fro piping.

Model	Connecting port screw size	Applicable O-ring	Applicable union (Port diameter)
MD-15RM	G3/4	AS-568-016	13A
MD-20RM		AS-568-017	16A
MD-20RXM	G1	AS-568-020	20A
MD-20RZM	G3/4	AS-568-016	13A
MD-30RM		AS-568-017	16A
MD-30RXM	G1	AS-568-020	20A
MD-30RZM	G3/4	AS-568-016	13A
MD-40RM		AS-568-017	16A
MD-40RXM	G1	AS-568-020	20A
MD-40RZM	G3/4	AS-568-017	16A
MD-40RZ-5M			
MD-55RM	G1	AS-568-020	20A
MD-55RM-5M			
MD-70RM			
MD-70RZM	G3/4	AS-568-017	16A
MD-100RM	G1	AS-568-020	20A
MD-100RM-5M			

7. Main Parts and Label

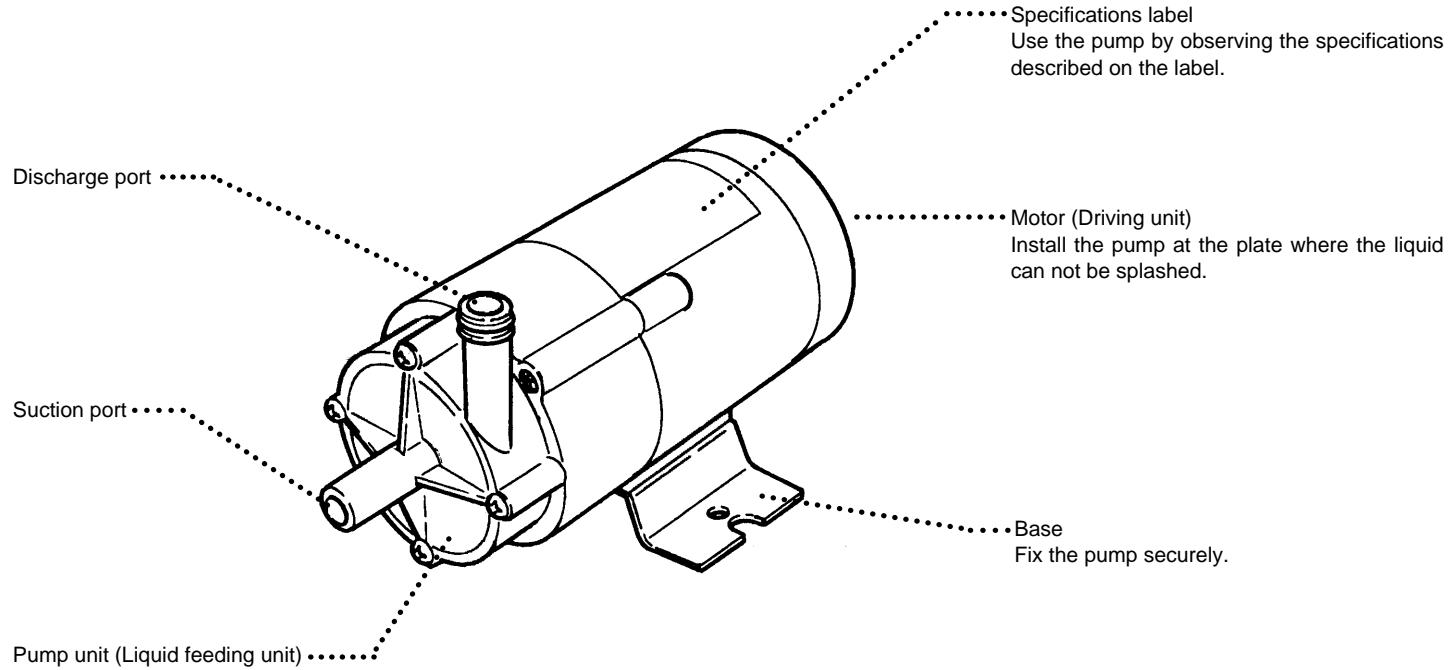

8. Name of Parts

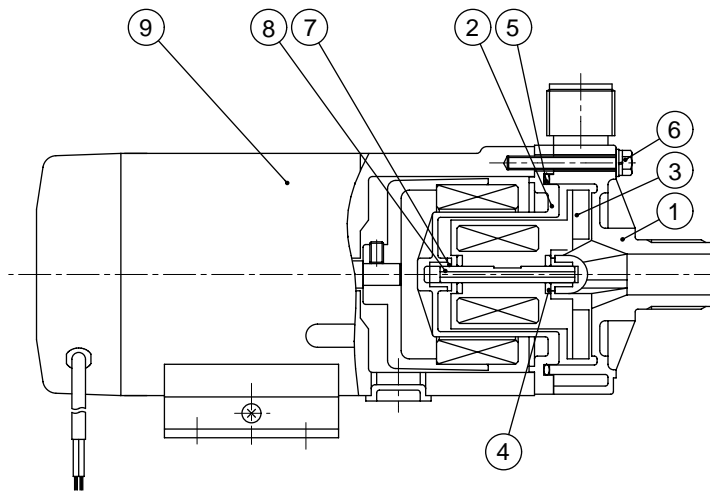

No.	Parts Name	Q'ty	Material
1	Front casing	1	GFRPP (Note 1)
2	Rear Casing	1	
3	Impeller	1	
4	Thrust	2	Ceramics
5	O ring	1	FKM or EPDM (Note 2)

No.	Parts Name	Q'ty	Material
6	Screw	4~6	Stainless steel
7	Bearing	2	Fluoresin containing filler material (Note 3)
8	Spindle	1	Ceramic
9	Motor	1	

Note 1: The material of the impeller used in MD-70RZ, MD-100R and MD-100R-5 models is CFRPP.

Note 2: EPDM is option.

Note 3: The material of the bearing used in MD-70RZ is PPS.

9. Handling

(1) Handle the pump carefully

Strong impacts caused by dropping the pump on the floor or striking it may result in damage or faulty performance.



(2) Priming water

Be sure to fill the pump unit with liquid as priming water before pump operation.



Caution
Operating the pump dry (operation without liquid) may cause seizure or wear of pump parts.

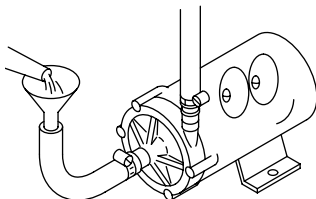

(3) Range of liquid temperature

0 ~ 80°C

The above range may differ depending on liquid. However, any liquid that freezes cannot be used. For details, contact Iwaki or your dealer.

- (4) As there is a powerful magnet inside the pump unit, do not use any liquid that contains metallic substances such as iron, nickel, etc.

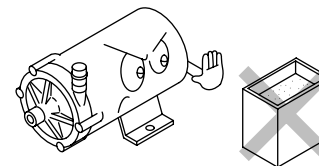

(5) Do not operate the pump in the following places.

- The pump unit is not designed to be dust and water-proof.
 - Places exposed to rain and/or wind
 - Places where the temperature falls below 0°C
 - Places where corrosive gas (such as chlorine gas) is generated.
 - Places exposed to splashing or dropping of water
 - Places where the ambient temperature is 40°C or above
 - Places where explosive.

- (6) The relative humidity should be 90% or below. Be careful not to allow dust and water inside the motor unit. The motor should not be splashed with water, otherwise it may short-circuit or burn.

(7) Do not operate the pump with the following liquids.

- For the compatibility to chemical liquid or any special liquid, contact IWAKI sales representative.
- Liquids that significantly swell polypropylene
 - Paraffinic hydrocarbons such as gasoline and kerosene
 - Halogenated hydrocarbons such as trichloroethylene and carbon tetrachloride
 - Ether and low-grade ester
- Slurry
(Never use slurry, which wears out the pump bearing.)

(8) Keep the pump away from fire.

To prevent fire and explosions, do not place dangerous or inflammable substances near the pump.

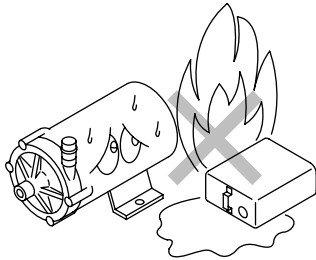

(9) Grounding

Be sure to connect the grounding cable (green/yellow). In addition, arrange an earth leakage breaker to prevent electrical shocks.

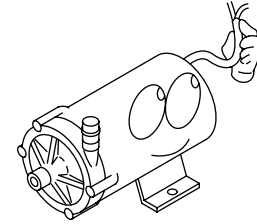

(10) If pump is damaged

Do not operate a damaged pump, otherwise there may happen the electricity leakage or electric shocks.

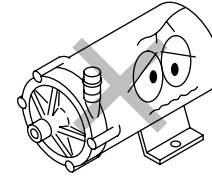

(11) Surface temperature

The surface temperature of the motor or the pump may be extremely high during the pump operation. Do not touch it directly.



(12) Sound generated by pump

The level of sound generated by the pump is shown in the table.

(dB)

Model	Sound * Level	Model	Sound * Level
MD-15R	40	MD-30RX MD-30RZ MD-40R MD-40RX MD-40RZ	60
MD-20R	45		
MD-20RX MD-20RZ	50	MD-55R	55
		MD-70R	70
MD-30R	55	MD-100R	75

*When measured at a distance of 1m A scale

10. Installation, Piping and Wiring

10-1. Installation

(1) Installation site

An installation site must be an ambient temperature of 0~40°C and a relative humidity of lower than 90%. Install the pump at the place where the maintenance and inspection work can be done easily.

(2) Pump installation method

This pump is not the selfpriming pump. The pump shall be installed in a position lower than the liquid level of the suction tank.

Liquid level must be higher by 30 cm than the pump suction port level. If this distance is too short, the air may be sucked in the pump, which will cause abnormal wear of pump bearing.

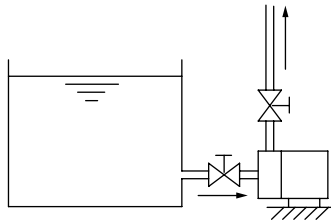

(3) Direction of pump discharge port

The discharge port can be directed as desired. However, for efficient elimination of the air out of the pump chamber, it is recommended that the discharge port is directed upward.

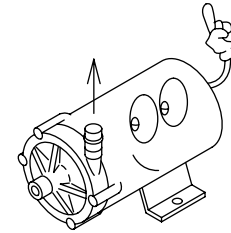

(4) Anchoring of base

The base of the pump must be anchored firmly.

The pump must not be mounted in a vertical position.

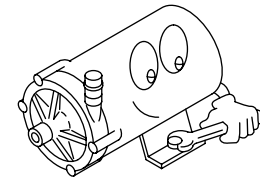

(5) Hose preparation

The ends of the hoses should be cut flat before connecting them.

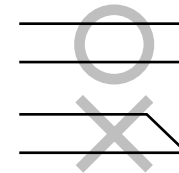

10-2. Piping

Piping instructions

- (1) To minimize the friction resistance, the shortest piping possible with the minimum number of bends should be utilized. Especially for suction piping, employ as larger and shorter hose as possible.
- (2) Use a corrosion-resistant vinyl hose that can endure the pressure made by the pump operation.

If the connection on the suction side is inadequate, air may be mixed in.

- (3) Hose size

Select a hose in accordance with the diameter of the pump port. A reliable connection is not guaranteed if different size of hose is used.

As the hose on the suction side, in particular, tends to be crushed under the sucking force, the use of a braided hose is recommended. **(In the case of hot liquid feeding, special attention must be paid in the selection of a hose.)**

- (4) Valve installation

Install valves close to the suction and discharge port.

- Suction side valve:
· For easy removal or maintenance of the pump.
- Discharge side valve:
· For adjustment of the discharge rate or head.

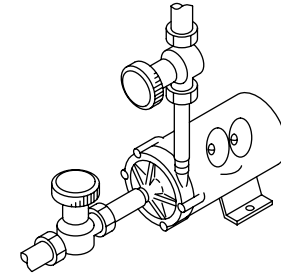

- (5) Hose connection

Press the hose end firmly against the discharge or suction port until it reaches the bottom of the port.

- *Use a fastener (such as a hose band) to make the connection firm and free of liquid leakage.



Caution
Do not tighten the connection ports (suction and discharge) excessively as they are made of plastic resin and are easily damaged.

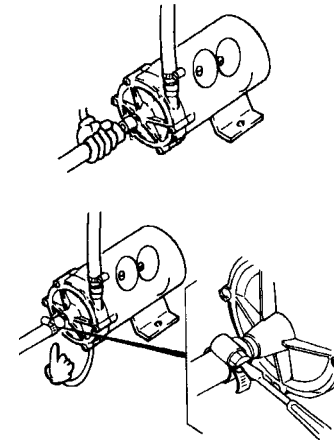

10-3. Wiring

- (1) Prior to wiring work, check the voltage specified on the name-plate.

Use specified wiring materials. (Observe the local regulations related with electrical work.) The connection diagram and the table showing the rated current and starting current for each model are presented below.

- (2) Do not fail to connect a ground wire (green/yellow).

- (3) The pump has no On/Off switch. It starts operation when power is supplied by connecting the power supply cable or other means.

Wiring diagram

- MD-15R, 20R, 20RX, 20RZ, 30R, 30RX and 30RZ models
(Single-phase capacitor run motor with thermal protector)

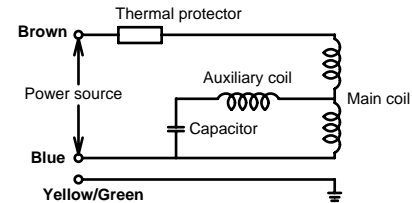

- MD-40R, 40RX, 40RZ, 40RZ-5, 55R, 55R-5, 70R, 70RZ, 100R and 100R-5 models
(Single-phase capacitor run motor with thermal protector)

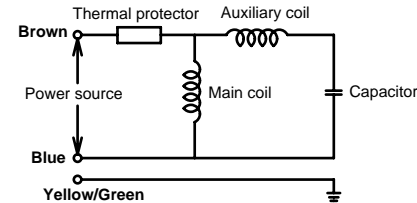

- MD-70R, 100R, 70RZ and 100R-5 models
(3-phase motor, 220/380V)

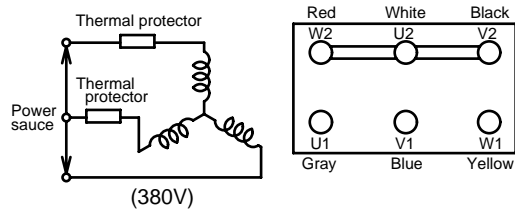
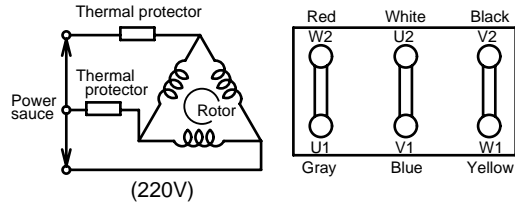

- MD-70R, 100R, 70RZ and 100R-5 models
(3-phase motor, 400/440V)

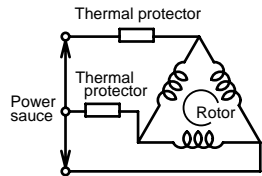

Rated Current and Starting Current (50/60Hz)

Model	Rated current (50/60Hz) (Amp.)			Starting current (50/60Hz) (Amp.)		
	220/240V (Single-phase)	220/380V (3-phase)	400/440V (3-phase)	220/240V (Single-phase)	220/380V (3-phase)	400/440V (3-phase)
MD-15R(M)	0.19 / 0.18	—	—	0.3 / 0.29	—	—
MD-20R(M)	0.24 / 0.28	—	—	0.4 / 0.4	—	—
MD-20RX(M)	0.24 / 0.29	—	—	0.4 / 0.4	—	—
MD-20RZ(M)	0.24 / 0.29	—	—	0.4 / 0.4	—	—
MD-30R(M)	0.4 / 0.5	—	—	1.2 / 1.25	—	—
MD-30RX(M)	0.4 / 0.5	—	—	1.2 / 1.25	—	—
MD-30RZ(M)	0.42 / 0.5	—	—	1.2 / 1.25	—	—
MD-40R(M)	0.52 / 0.7	—	—	1.1 / 1.0	—	—
MD-40RX(M)	0.46 / 0.58	—	—	1.1 / 1.0	—	—
MD-40RZ(M)	0.65 / 0.85	—	—	1.25 / 1.35	—	—
MD-40RZ-5(M)	0.65 / -	—	—	1.25 / -	—	—
MD-55R(M)	0.8 / 0.9	—	—	2.3 / 2.1	—	—
MD-55R-5(M)	1.0 / -	—	—	2.3 / 2.1	—	—
MD-70R(M)	1.21 / 1.64 / 1.21 / 1.50	1.15 / 1.3 / 0.64 / 0.69	0.39 / 0.46 / 0.4 / 0.45	3.15 / 2.9 / 3.55 / 3.2	3.9 / 3.8 / 2.25 / 2.2	1.24 / 1.22 / 2.27 / 1.25
MD-70RZ(M)	1.4 / 1.9	1.2 / 1.3 / 0.7 / 0.8	0.6 / 0.7	3.15 / 2.95 / 3.42 / 3.15	4.15 / 4.0 / 2.45 / 2.4	2.15 / 2.05 / 2.3 / 2.27
MD-100R(M)	1.93 / 1.85 / 1.93 / 1.83	1.18 / 1.17 / 0.69 / 0.87	0.62 / 0.6 / 0.6 / 0.58	3.8 / 3.6 / 4.3 / 4.0	3.8 / 3.7 / 2.2 / 2.1	1.9 / 1.85 / 2.2 / 2.1
MD-100R-5(M)	1.93 / -	1.18 / -	0.62 / -	3.8 / -	3.8 / -	1.9 / -

11. Operation

Operation instructions



Caution

- *Before operating the pump, confirm that the hoses connected with the discharge port and suction port are firmly fixed in position.*
- *Dry operation (operation without liquid in the pump) damages the pump. Be sure to fill the pump with priming liquid in advance.*
- *Do not keep on operating the pump with entirely or almost closed discharge or/and suction side valve(s).*
- *Do not open or close the suction or discharge side valve suddenly, otherwise the magnet coupling may be detached, disabling the rotation of the impeller. (Under such circumstances, turn off the power supply. When the motor stops rotating, the coupling will be connected.)*

Operation

After the installation, piping and wiring processes are completed, operate the pump in accordance with the following steps.

No.	Operation Step	Description (Points to be Checked)
1	Check piping, wiring and voltage.	Check in accordance with the 'Hose connection' and 'Wiring' sections. Check the power supply voltage by referring to the information on the nameplate.
2	Open and close valves.	<ul style="list-style-type: none"> • Fully open suction side valve. • Fully close discharge side valve.
3	Check that pump chamber is filled with liquid.	<ul style="list-style-type: none"> • Fill pump chamber with priming water (feeding liquid). Carry out sufficient priming in case of suction lift method.
4	Supply power to pump	After steps 1 to 3 above, connect power supply to start pump.

No.	Operation Step	Description (Points to be Checked)
5	Adjust discharge capacity & head to desired values.	Adjust discharge side valve gradually till desired discharge capacity and head are obtained. <u>Do not open or close valves suddenly.</u> Note: Do not keep discharge side valve closed for more than 1 minute. Note: Check that pump feeds liquid normally. If not, turn off power immediately and eliminate cause referring to 'Causes of Trouble and Troubleshooting' section (p.27).
6	Checkpoints during operation	<ul style="list-style-type: none"> • Be careful to prevent foreign matter from entering pump. Foreign matter in pump may cause impeller to be locked, hindering liquid circulation. Motor itself continues to rotate even if impeller is locked. In such a case, turn off power supply at once. • When earth leakage breaker is activated, turn off power supply at once and eliminate cause by referring to 'Causes of Trouble and Troubleshooting' section.

Pump Stopping Procedure

No.	Stopping Step	Description
1	Close discharge side valve.	Close discharge side valve gradually. Do not use electromagnetic valve for quick closing.
2	Turn off power supply. (Check stopping condition.)	Check that motor stops smoothly after power supply is disconnected. If not, pump should be inspected. (For details, contact Iwaki or your dealer.)

How to store pump when it is out of use for a long time

Remove the liquid from the pump if it is to be stored for a long time. In addition, run it with water circulating for about 5 minutes every 3 months to prevent rust on the motor bearing.

Draining Method

Warning

- *Before starting the draining procedure, turn off the power supply.*
- *Be sure to wear proper safety gear (gloves, protective shoes, etc.) during draining work. When chemical liquid is used, wear rubber gloves, goggles.*

Caution

- *Pay special attention to the remaining liquid which may run out of the discharge port or the suction port when removing the hose. Pay attention not to allow the motor or electric parts to come into contact with the liquid.*
- *Never discharge hazardous or chemical liquid over the ground or floor in the plant. Instead, use a draining pan (or container). Observe each applicable local law or regulation for the handling or disposal of hazardous liquids.*

Draining procedure:

- (1) Turn off the power supply.
(Make sure no other operator will turn on the power supply accidentally.)
- (2) Close the discharge and suction sides valves fully.
- (3) Remove the hoses connected with the discharge port and the suction port.
Position the draining pan below the pump unit in advance. Loosen the hose band and rotate the hose clockwise and counter-clockwise slowly to completely pull the hose off of each port. (Liquid will run out when the hose is disconnected.)
- (4) Remove the screws on the pump base to detach the pump unit.
- (5) Direct the discharge port downward to drain the liquid into the draining pan.
Never discharge hazardous liquid, over the ground or the floor inside the plant. Use a draining pan (or container).

12. Causes of Trouble and Troubleshooting

Cause \ Trouble	Pump does not start.	Pumping is not done or insufficient.	Electric current is too high.	Excessive noise or vibration.	Liquid leaks.	Troubleshooting
Power is not supplied or wiring is faulty.						Supply power or contact your dealer.
Motor is out of order (disconnected coil or capacitor failure).						Contact your dealer.
There is residual air in the pump.						Eliminate air completely.
Air is sucked in via suction port.						Fasten hose tightly.
Pump is driven dry.						Supply priming water to pump.
Specific gravity/viscosity of liquid is too high.						Use suitable type of pump.
Periphery of impeller magnet is in contact with rear casing.						Contact your dealer.
Impeller is damaged.						Contact your dealer.
Foreign matter adheres to impeller.						Contact your dealer.
O ring is damaged.						Contact your dealer.
Loosened front casing fixing bolts.						Tighten bolts.

**IWAKI PUMPS**IWAKI CO.,LTD. 6-6 Kanda-Sudacho 2-chome Chiyoda-ku Tokyo 101-8558 Japan
TEL:(81)3 3254 2935 FAX:3 3252 8892(<http://www.iwaki-pumps.co.jp/>)

()Country codes

Singapore : IWAKI Singapore Pte. Ltd.	TEL : (65)763 2744 FAX:763 2372	Germany : IWAKI EUROPE GmbH	TEL : (49)2154 9254 0 FAX:2154 1028
Indonesia : IWAKI Singapore (Indonesia Branch)	TEL : (62)21 392 8288 FAX:21 392 8088	Italy : IWAKI Italia S.R.L.	TEL : (39)02 9903931 FAX:02 99042888
Malaysia : IWAKIm Sdn. Bhd	TEL : (60)3 703 8807 FAX:3 703 4800	Denmark : IWAKI Pumper A/S	TEL : (45)48 24 2345 FAX:48 24 2346
Taiwan : IWAKI Pumps Taiwan Co.,Ltd.	TEL : (886)2 2776 5900 FAX:2 2740 2812	France : IWAKI France S.A.	TEL : (33)1 69 63 33 70 FAX:1 64 49 92 73
Thailand : IWAKI (Thailand) Co.,Ltd.	TEL : (66)2 322 2471 FAX:2 322 2477	Switzerland : IWAKI (Schweiz) AG	TEL : (41)32 3235024 FAX:32 3226084
Hong Kong : IWAKI Pumps Co.,Ltd.	TEL : (852)2 607 1168 FAX:2 607 1000	U.K. : IWAKI PUMPS (UK) LTD	TEL : (44)1743 231363 FAX:1743 366507
China : IWAKI Pumps Co.,Ltd. (Shanghai office)	TEL : (86)21 5234 0776 FAX:21 5234 0775	Sweden : IWAKI Sverige AB	TEL : (46)8 511 72900 FAX:8 511 72922
China : IWAKI Pumps Co.,Ltd. (Beijing office)	TEL : (86)10 6262 6678 FAX:10 6262 6551	Finland : IWAKI Suomi Oy	TEL : (358)9 2742714 FAX:9 2742715
China : IWAKI Pumps Co.,Ltd. (Guangzhou office)	TEL : (86)20 8130 0605 FAX:(86)20 8130 0601	Austria : IWAKI (Austria) GmbH	TEL : (43)2236 33469 FAX:2236 33469
Australia : IWAKI Pumps Australia Pty. Ltd.	TEL : (61)2 9899 2411 FAX:2 9899 2421	Norway : IWAKI Norge AS	TEL : (47)66 80 66 86 FAX:66 80 66 87
U.S.A. : IWAKI WALCHEM Corporation	TEL : (1)508 429 1440 FAX:508 429 13864	Holland : IWAKI Holland B.V.	TEL : (31)297 241121 FAX:297 273902
		Spain : IWAKI Iberica Pumps,S.A.	TEL : (34)943 630030 FAX:943 628799
		Belgium : IWAKI Belgium n.v.	TEL : (32)1430 7007 FAX:1430 7008

T385 00/8